



苏州嘉多利精密电子有限公司

Charter Leader Precision Electronic Co.,Ltd.

产品规格书

Specification

Model: AD75-75-70

No	项目 Items	描述 Description
1	外部尺寸(W*D*H) External	750*750*700 mm (不含电控箱和外部配件)
2	工作尺寸(W*D*H) Inner	670*670*680 mm
3	操作方式 Operation mode	自动操作 Pneumatic
4	表面处理 Surface treatments	白色烤漆 white paint
5	吸波材料 Absorber	吸波胶/吸波棉
6	隔离度 Isolation	> 80dB (900M ~ 8GHz) > 75dB (8G ~ 60GHz)
7	其它 Other	



苏州嘉多利精密电子有限公司

Charter Leader Precision Electronic Co.,Ltd.

箱体3D

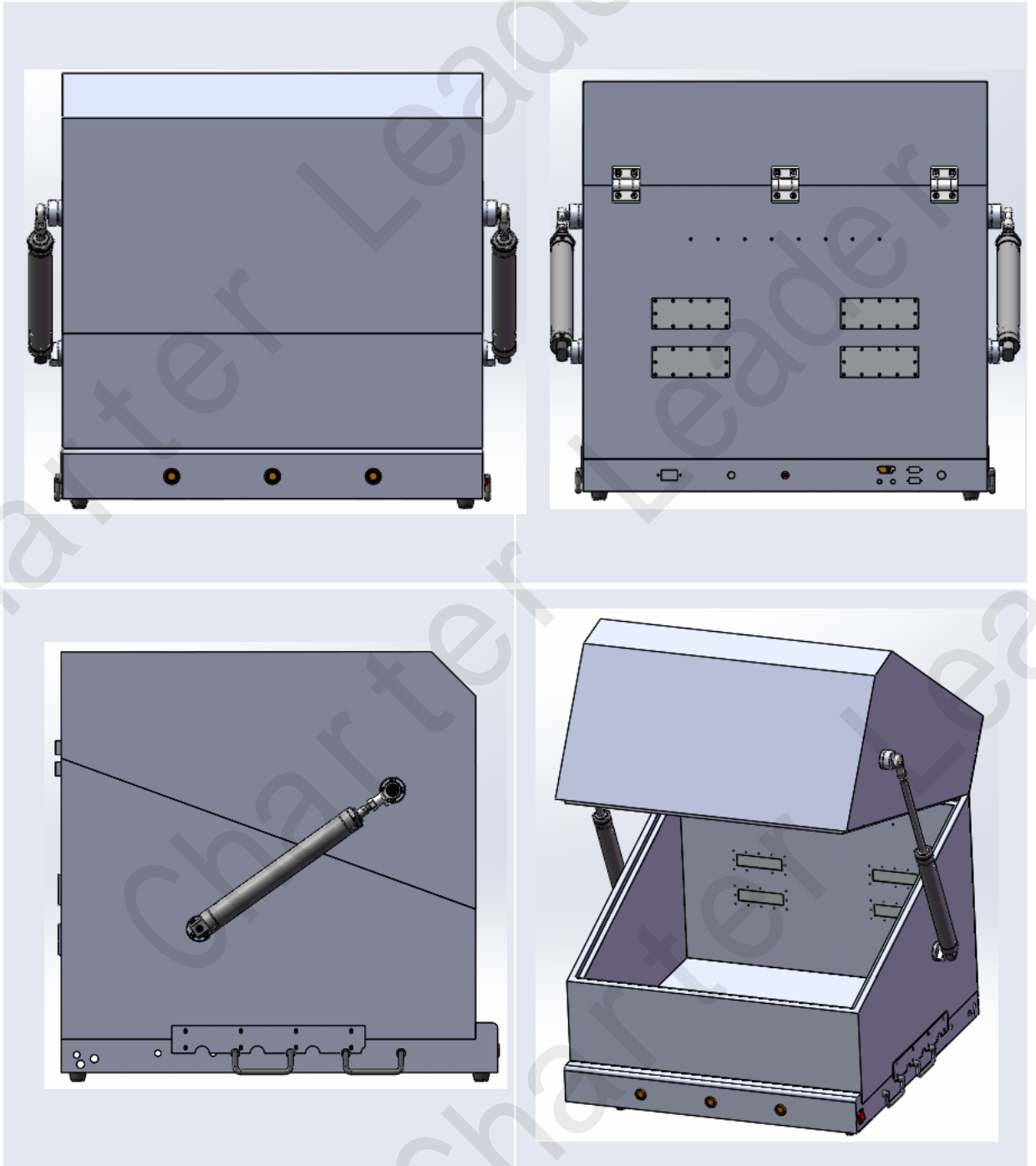



苏州嘉多利精密电子有限公司

Charter Leader Precision Electronic Co.,Ltd.

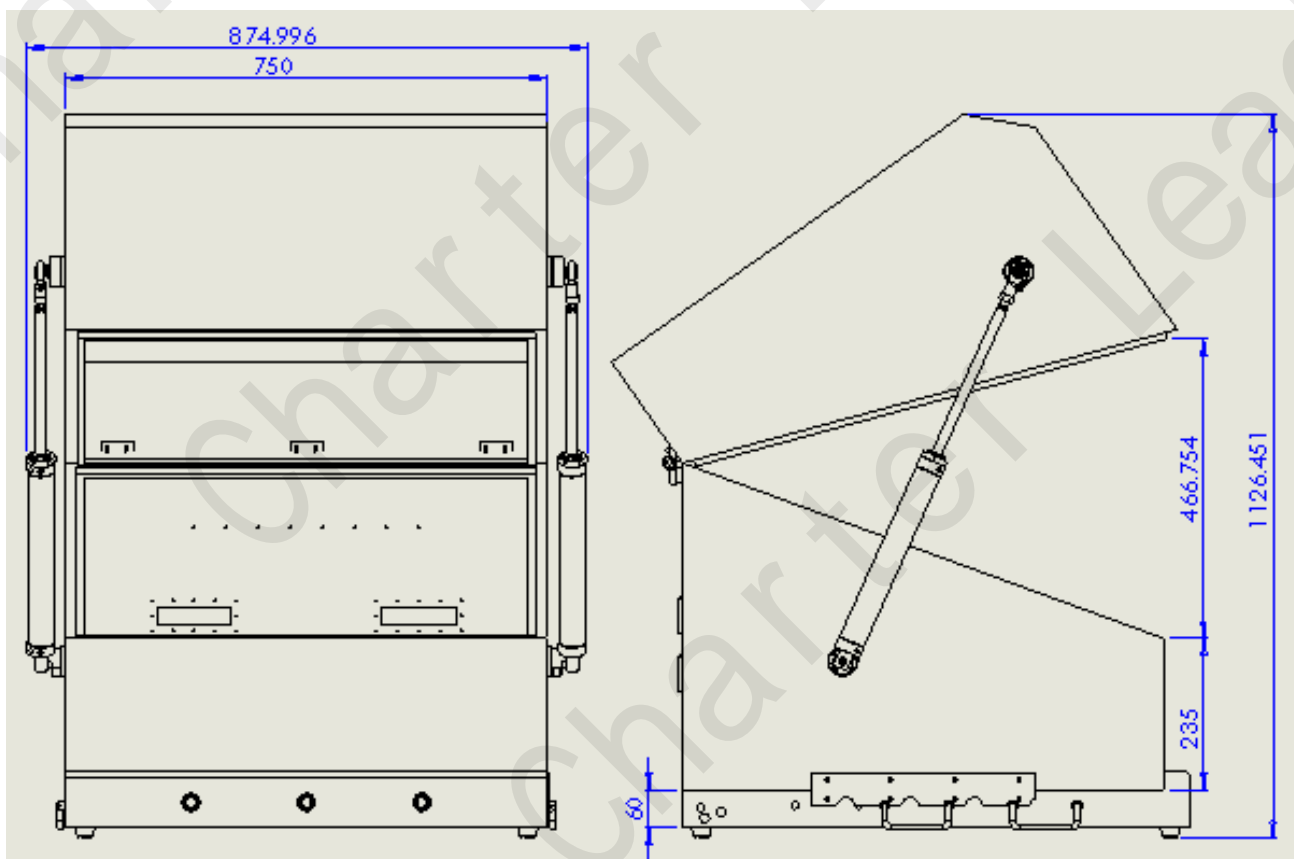
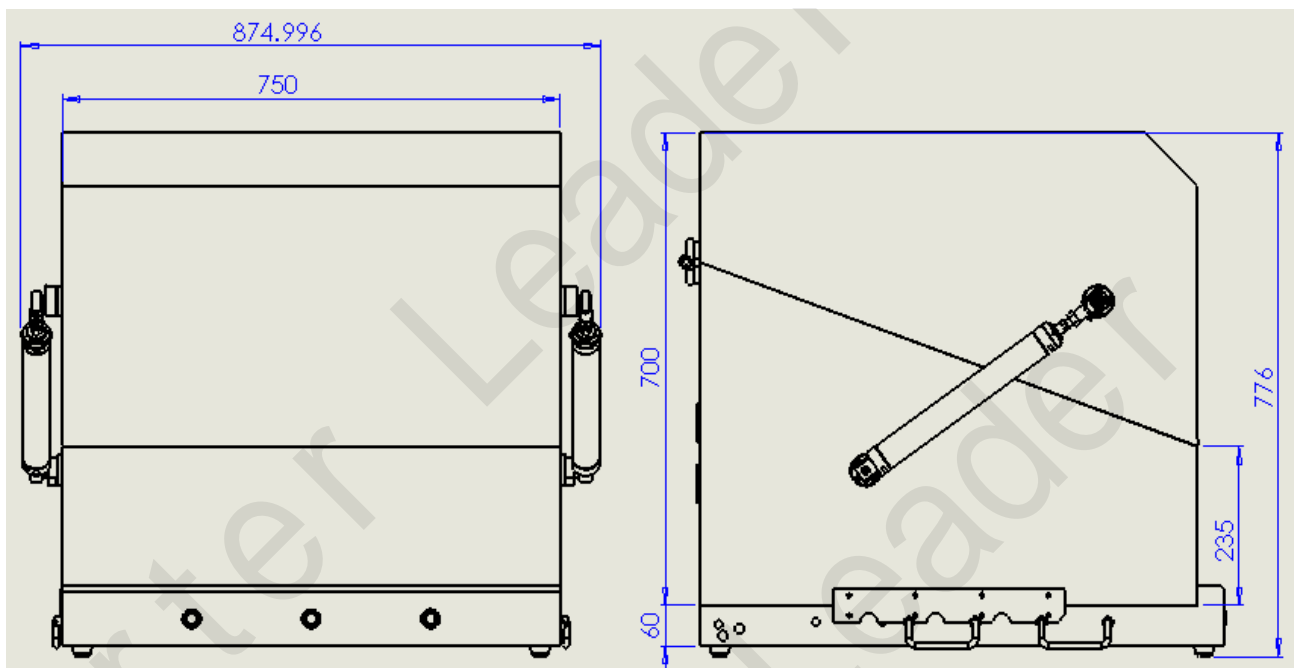



苏州嘉多利精密电子有限公司

Charter Leader Precision Electronic Co.,Ltd.

滤波器选项 Option Filter

Photo	P/N	Description
	F401	标准4合1 (4 in 1) 1 of RS232 or VGA 3 of (RJ45,DC,USB2.0,USB3.0,HDMI,Audio,PS2) 选3任意组合
	F501	标准5合1 (5 in 1) 5 of (RJ45,DC,USB2.0,USB3.0,HDMI,AUDIO,PS2) 选5任意组合
	FD01	DB25+DB9
	FG01	气管滤波器 Gas connector
	FS01	SMA
	FB01	挡板
	FAC01	外公内母 (3Pin) (内美标) Male Outside to Female Inside (American Standard)
	FAC02	外公内母 (3Pin) (内国标) Male Outside to Female Inside